

Agreement No. ZECO/GR/06/2022/06



CONTRACT AGREEMENT

BETWEEN

ZANZIBAR ELECTRICITY COOPERATION

AND

TANZANIA CLOU ELECTRONICS CO. LIMITED

FOR THE SUPPLY OF METERS UNDER COVID 19 PROJECT

THIS CONTRACT AGREEMENT is made this *08* day of *February*..... 2022

BETWEEN

Zanzibar Electricity Corporation of P.O. Box 235, Gulioni, Zanzibar (hereinafter referred to as “the Client” which expression includes its successor and assignee) of the one part,

AND

Tanzania Clou Electronics Co. Limited of P.O.BOX 22786, Dar es Salaam (hereinafter referred to as “the Supplier” which expression includes its successor and assignee) of the other part:

WHERE AS:

- a. The Purchaser is an autonomous body established under the laws of Zanzibar for the Supply of Electricity,
- b. The Supplier is an undertaking registered under the laws of Tanzania and which authorized to trade in the business of supplying **Meters** within Zanzibar, and

MH

Rs

- c. The Purchaser is in demand of the **Meters** in the sum of **TZS One Billion, Five Hundred Fourteen Million, Three Hundred Thousand Sixty Six Thousand, Seven Hundred Eighty Four.** in words (**TZS 1,514,366,784.00**) **VAT EXCLUSIVE**

THEREFORE, ON THE BASIS OF PRINCIPLES OF EQUALITY AND MUTUAL INTERESTS, THE PARTIES DO HEREBY AGREE AS:

1. The following documents are forming part to the contract and shall be considered as mutually explanatory of one another: -
 - a. This Form of Contract
 - b. Price Schedule submitted by the Tenderer;
 - c. the Schedule of Requirements;
 - d. the Technical Specifications;
 - e. the manufacturer authorization;
 - f. the anti-bribery/ code of conduct,
 - g. the Special Conditions of Contract;
 - h. the General Conditions of Contract and;
 - i. Power of attorney;
2. This contract shall prevail over the other documents part of the contract and in the event of any discrepancy or inconsistency within the contract documents, the documents shall prevail in the descending order as arranged in the clause 1 of this contract.
3. In consideration of the payments to be made by the Purchaser to the **Supplier** as hereinafter stated, the **Supplier** shall supply the **Meters** to the Purchaser in conformity, in all respect, with the provision of the Contract and remedy defects therein.
4. Subject to clause 3 of this contract, the **Purchaser** hereby covenants to pay the **Supplier** in consideration of the supply,

MH

RS

5. the contract price or such other sum as may become payable under the provisions of the Contract at the times and in the manner prescribed in the Contract.
6. This contract may not be amended, or otherwise extended, except by written contract between the parties and no other purported amendment or extension thereof shall be effective.

IN WITNESS WHEREOF, the parties hereto have, through their duly authorized agents, set their hands the day, month and the year as herein indicated.

Signed for and on behalf of the **Supplier:**

Name RASHID SALUM HUMOUD In the presence of:

Designation OPERATION MANAGER Name MALYA YAMUNGA

Signature [Signature]
08/02/2022



Signature [Signature]

Signed for and on behalf of the **Purchaser:**

Name MSHENGA H. MSHENGA In the presence of:

Designation GENERAL MANAGER Name ARAFI S. KHAMIS

Signature [Signature]

Signature [Signature]

MH

RS

General Conditions of Contract

1.	Definit ions	1.1	In this Contract, the following terms shall be interpreted as indicated:
			a) "The Contract" means the agreement entered into between the Purchaser and the Supplier, as recorded in the Contract Form signed by the parties, including all attachments and appendices thereto and all documents incorporated by reference therein.
			b) "Completion" means the fulfillment of the related services by the Supplier in accordance with the terms and conditions set forth in the contract
			c) "The Contract Price" means the price payable to the Supplier as specified under the Contract, subject to such additions and adjustment here to or deduction there from as may be made pursuant to the contract for the full and proper performance of its contractual obligations.
			d) "Delivery" means the transfer of the goods from the supplier equipment, machinery, and /or other materials, which the Supplier is required to supply to the Purchaser under Contract.
			f) "The Related Services" means those services ancillary to the supply of the Goods, such

RS

MH

				as transportation and insurance, and any other incidental services, such as installation, commissioning, provision of technical assistance, training, initial maintenance and other such obligations of the Supplier covered under the Contract.
			g)	“GCC” means the General Conditions of Contract contained in this section.
			h)	“SCC” means the Special Conditions of Contract.
			i)	“The Purchaser” means the entity purchasing the Goods and related service, as named in SCC .
			j)	“The Supplier” means the individual private or government entity or a combination of the above who’s Tender to perform the contract has been accepted by the Purchaser and is named as such in the Contract Agreement, and includes the legal successors or permitted assigns of the supplier.
			k)	“The Project Site” where applicable, means the place or places named in SCC.
			l)	“Day” means calendar day.
			m)	“Effective Date” means the date on which this Contract becomes effective pursuant to GCC Clause
			n)	“Origin” means the place where the Goods were mined, grown, or produced or from which the Services are supplied. Goods are produced when, through manufacturing, processing, or substantial and major

Rs

MA

			assembly of components, a commercially recognized new produce results that is substantially different in basic characteristics or in purpose or utility from its components.
			o) "End User" means the organization(s) where the goods will be used, as named in the SCC .
			p)
			q) "Force Majeure" means an event or situation beyond the control of the Supplier and not involving the Supplier's fault or negligence and not foreseeable, is unavoidable, and is not due to negligence or lack of care on the part of the Supplier.
2.	Applic ation	2.1	These General Conditions shall apply to the extent that provisions of other parts of the Contract do not supersede them.
3.	Govern ing Langua ge	3.1	The Contract as all correspondence and documents relating to the contract exchanged by the Supplier and the Purchaser shall be written in the language specified in SCC . Subject to GCC Clause 3.1, the version of the Contract written in the specified language shall govern its interpretation.
4.	Applic able Law	4.1	The contract shall be governed and interpreted in accordance with the laws of Zanzibar, unless otherwise specified in SCC .
5.	Countr y of Origin	5.1	The origin of Goods and Services is distinct from the nationality of the Supplier.

MH

Rs

6.	Standards	6.1	The Goods supplied under this Contract shall conform to the standards mentioned in the Technical Specifications, and, when no applicable standard is mentioned, to the authoritative standards appropriate to the Goods' country of origin. Such standards shall be the latest issued by the concerned institution.
7.	Use of Contract Documents and Information; Inspection and Audit by the Government of Zanzibar	7.1	The Supplier shall not, without the Purchaser's prior written consent, disclose the Contract, or any provision thereof, or any specification, plan, drawing, pattern, sample, or information furnished by or on behalf of the Purchaser in connection therewith, to any person other than a person employed by the Supplier in the performance of the Contract. Disclosure to any such employed person shall be made in confidence and shall extend only so far as may be necessary for purposes of such performance.
		7.2	The Supplier shall not, without the Purchaser's prior written consent, make use of any document or information enumerated in GCC Clause 7.1 except for purposes of performing the Contract.
		7.3	Any document, other than the Contract itself, enumerated in GCC Clause 7.1 shall remain the property of the Purchaser and shall be returned (all copies) to the Purchaser on completion of the Supplier's performance under the Contract if so required by the Purchaser.

MH

Rs

		7.4	The Supplier shall permit the Revolutionary Government of Zanzibar or / and donor agencies involved in financing the project to inspect the Supplier's accounts and records relating to the performance of the Supplier and to have them audited by auditors appointed by the Revolutionary Government of Zanzibar or / and the appropriate donor agencies, if so required by the Revolutionary Government of Zanzibar or / and the appropriate donor agencies.
8.	Patent and Copyrights	8.1	The Supplier shall indemnify the Purchaser against all third-party claims of infringement of patent, trademark, or industrial design rights arising from use of the Goods or any part thereof in Zanzibar.
		8.2	The patent right in all drawings, documents, and other materials containing data and information furnished to the Purchaser by the Supplier herein shall remain vested in the supplier, or, if they are furnished to the Purchaser directly, or through the Supplier by any third party, including suppliers of materials, the patent right in such materials shall remain vested in such third party.
9.	Performance Security	9.1	Within thirty (30) days of receipt of the notification of Contract award, the successful Tenderer shall furnish to the Purchaser the performance security in the amount specified in SCC.
		9.2	The proceeds of the performance security shall be payable to the Purchaser as compensation for any loss resulting from the Supplier's failure to complete its obligations under the Contract.

Rs

MH

		9.3	The performance security shall be denominated in the currency of the Contract, or in a freely convertible currency acceptable to the Purchaser and shall be in one of the following forms:
			a) A bank guarantee, an irrevocable letter of credit issued by a reputable bank, or an insurance bond issued by a reputable insurance firm located in Zanzibar/Tanzania or abroad, acceptable to the Purchaser, in the form provided in the Tendering documents or another form acceptable to the Purchaser; or
			b) A cashier's or certified check.
		9.4	The performance security will be discharged by the Purchaser and returned to the Supplier not later than thirty (30) days following the date of completion of the Supplier's performance obligations under the Contract, including any warranty obligations, unless otherwise specified in SCC .
10	Inspections and Test	10.1	The Purchaser or its representative shall have the right to inspect and /or to test the Goods to confirm their conformity to the Contract specifications at no extra cost to the Purchaser. SCC and the Technical Specifications shall specify what inspections and tests the Purchaser shall notify the Supplier in writing, in a timely manner, of the identity of any representatives retained for these purposes.

MH

Rs

		10.2	The inspections and tests may be conducted on the premises of the Supplier or its subcontractor(s), at point of delivery, and/or at the Goods' final destination. If conducted on the premises of the Supplier or its subcontractor(s), all reasonable facilities and assistance, including access to drawings and production data, shall be furnished to the inspectors at no charge to the Purchaser.
		10.3	Should any inspected or tested Goods fail to conform to the Specifications, the Purchaser may reject the Goods, and the Supplier shall replace the rejected Goods to meet specification requirements free of cost to the Purchaser.
		10.4	The Purchaser's right to inspect, test and, where necessary, reject Goods after the Goods' arrival in the Purchaser's country shall in no way be limited or eared by reason of the Goods having previously been inspected, tested, and passed by the Purchaser or its representative prior to the Goods' shipment from the country of origin.
		10.5	Nothing in GCC Clause 10 shall in any way release the supplier from any warranty or other obligations under this Contract.

MH

Rs

1 1	Packin g	11.1	The supplier shall provide such packing of the Goods as is required to prevent their damage or deterioration during transit to their final destination, as indicated in the Contract. The packing shall be sufficient to withstand, without limitation, rough handling during transit and exposure to extreme temperatures, salt and precipitation during transit, and open storage. Packing case size and weights shall take into consideration, where appropriate, the remoteness of the Goods final destination and the absence of heavy handling facilities at all points in transit.
		11.2	The packing, marking, and documentation within and outside the packages shall comply strictly with such special requirements as shall be expressly provided for in the Contract, including additional requirements, if any, specified in SCC , and in any subsequent instructions ordered by the Purchaser.
1 2	Deliver y and Docum ents	12.1	The Supplier in accordance with the terms specified in the Schedule of Requirements shall make delivery of the Goods. The details of shipping and / or other documents to be furnished by the Supplier are specified in SCC .
		12.2	For purposes of the Contract, "EXW" "FOB" "FCA", "CIF", "CIP," and other trade terms used to describe the obligations of the parties shall have the meanings assigned to them by the current edition of INCOTERMS published by the International Chamber of Commerce, Paris.
		12.3	Documents to be submitted by the Supplier are specified in SCC .

MH

RS

1 3	Insurance	13.1	The Goods supplied under the Contract shall be fully insured in a freely convertible currency against loss or damage incidental to manufacture or acquisition, transportation, storage, and delivery in the manner specified in the SCC.
1 4	Transportation	14.1	Where the Supplier is required under Contract to deliver the Goods FOB, transport of the Goods, up to and including the point of putting the Goods on board the vessel at the specified port of loading, shall be arranged and paid for by the Supplier, and the cost thereof shall be included in the Contract Price. Where the Supplier is required under the Contract to deliver the Goods FCA, transport of the Goods and delivery into the custody of the carrier at the place named by the Purchaser or other agreed point shall be arranged and paid for by the Supplier, and the cost thereof shall be included in the Contract Price.
		14.2	Where the Supplier is required under Contract to deliver the Goods CIF or CIP, transport of the Goods to the port of destination or such other named place of destination in Dar-es- Salaam, as shall be specified in the Contract, shall be arranged and paid for by the Supplier, and the cost thereof shall be included in the Contract Price.

MH

Rs

		14.3	Where the Supplier is required under the Contract to transport the Goods to a specified place of destination within Zanzibar, defined as the Project Site, transport to such place of destination in Zanzibar, including insurance and storage, as shall be specified in the Contract, shall be arranged by the Supplier, and related costs shall be included in the Contract Price.
1 5.	Incidental Services	15.1	The Supplier may be required to provide any or all of the following services, including additional services, if any, specified in SCC:
		a)	Performance or supervision of on-site assembly and/or start-up of the supplied Goods;
		b)	Furnishing of tools required for assembly and/or maintenance of the supplied Goods;
		c)	Furnishing of a detailed operations and maintenance manual for each appropriate unit of the supplied Goods;
		d)	Performance or supervision or maintenance and/or repair of the supplied Goods, for a period of time agreed by the parties, provided that this service shall not relieve the Supplier of any warranty obligations under this Contract; and.
		e)	Training of the Purchaser's personnel, at the Supplier's plant and/or on-site, in assembly, start-up, operation, maintenance, and/or repair of the supplied Goods.

MH

Rs

		15.2	Prices charged by the Supplier for incidental services, if not included in the Contract Price for the Goods, shall be agreed upon in advance by the parties and shall not exceed the prevailing rates charged to other parties by the Supplier for similar services
1 6.	Spare Parts	16.1	As specified in SCC , the Supplier may be required to provide any or all of the following materials, notifications, and information pertaining to spare parts manufactured or distributed by the Supplier:
		a)	Such spare parts as the Purchaser may elect to purchase from the Supplier, provided that this election shall not relieve the Supplier of any warranty obligations under the Contract; and
		b)	In the event of termination of production of the spare parts: <ul style="list-style-type: none"> i) advance notification to the Purchaser of the pending termination, in sufficient time to permit the Purchaser to procure needed requirements; and ii) Following such termination, furnishing at no cost to the Purchaser, the blueprints, drawings, and specifications of the spare parts, if requested.

MH

Rs

1 7.	Warrant y	17.1	The Supplier warrants that the Goods supplied under the Contract are new, unused, of the most recent or current models and those they incorporate all recent improvements in design and materials unless provided otherwise in the Contract. The Supplier further warrants that all Goods supplied under this Contract shall have no defect, arising from design, materials, or workmanship (except when the design and/or material is required by the Purchaser, specifications) or from any act or omission of the Supplier that may develop under normal use of the supplied Goods in the conditions prevailing in Zanzibar.
		17.2	This warranty shall remain valid for a period specified in the SCC after the Goods, or any portion thereof as the case may be, have been delivered to and accepted at the final destination indicated in the Contract, or for a period specified in the SCC after the date of shipment from the port or place of loading in the source country, whichever period concludes earlier, unless specified otherwise in SCC.
		17.3	The Purchaser shall promptly notify the Supplier in writing of any claims arising under this warranty.

RS

MH

		17.4	Upon receipt of such notice, the Supplier shall, within the period specified in SCC and with all reasonable speed, repair or replace the defective Goods or parts thereof, without costs to the Purchaser other than, where applicable, the cost of inland delivery of the repaired or replaced Goods or parts from EXW or the port or place of entry to entry to the final destination.
		17.5	If the Supplier, having been notified, fails to remedy the defect(s) within the period specified in SCC , the Purchaser may proceed to take such remedial action as may be necessary, at the Supplier's risk and expense and without prejudice to any other rights which the Purchaser may have against the Supplier under the Contract.
1	Paymen	18.1	The method and conditions of payment to be made to the Supplier under this Contract shall be specified in SCC .
8.	t	18.2	The Supplier's request(s) for payment shall be made to the Purchaser in writing, accompanied by an invoice describing, as appropriate, the Goods delivered and Services performed, and by documents submitted pursuant to GCC Clause 12, and upon fulfillment of other obligations stipulated in the Contract.

MH

RS

		18.3	The Purchaser shall make payments promptly, within sixty (60) days after submission of an invoice or claim by the Supplier. If the Purchaser makes a late payment, the Supplier shall be paid interest on the late payment. Interest shall be calculated from the date by which the payment should have been made up to the date when the late payment is made at the rate as specified in the SCC .
		18.4	The currency or currencies in which payment is made to the Supplier under this Contract shall be specified in SCC subject to the following general principle: payment will be made in the currency or currencies in which the payment has been requested in the Supplier's Tender.
		18.5	All payments shall be made in the currency or currencies specified in the SCC pursuant to GCC Clause 18.4
1	Prices	19.1	The contract price shall be as specified in the Contract Agreement Subject to any additions and adjustments thereto or deductions there from, as may be made pursuant to the Contract.
9.		19.2	Prices charged by the Supplier for Goods delivered and Services performed under the Contract shall not vary from the prices quoted by the Supplier in its Tender, with the exception of any price adjustments authorized in SCC or in the Purchaser's request for Tender validity extension, as the case may be.

MH

Rs

20. Change Orders	20.1	The Purchaser may at any time, by a written order given to the Supplier pursuant to GCC Clause 21, make changes within the general scope of the Contract in any one or more of the following:
	a)	Drawings, designs, or specifications, where Goods to be furnished under the Contract are to be specifically manufactured for the Purchaser;
	b)	The method of shipment or packing;
	c)	The place of delivery; and/or
	d)	The Services to be provided by the Supplier.
	20.2	If any such change causes an increase or decrease in the cost of, or the time required for, the Supplier's performance of any provisions under the Contract an equitable adjustment shall be made in the Contract Price or delivery schedule, or both, and the Contract shall accordingly be amended. Any claims by the Supplier for adjustment under this clause must be asserted within thirty (30) days from the date of the Supplier's receipt of the Purchaser's change order.
	20.3	Prices to be charged by the supplier for any related services that might be needed but which were not included in the Contract shall be agreed upon in advance by the Parties and shall not exceed the prevailing rates charged to other parties by the Supplier for similar services.
21. Contract Amendments	21.1	Subject to GCC Clause 20, no variation in or modification of the terms of the Contract shall be made except by written amendment signed by the parties.

MH

Rs

2 2	Assignment	22.1	Neither the Purchaser nor the Supplier shall assign, in whole or in part, obligations under this Contract, except with the prior written consent of the other party.
2 3	Subcontracts	23.1	The Supplier shall notify the Purchaser in writing of all subcontracts awarded under this contract if not already specified in the Tender. Such notification, in the original Tender or later, shall not relieve the Supplier from any liability or obligation under the contract.
		23.2	Subcontracts must comply with the provision of GCC Clause 5.

24	Delays in the Supplier's Performance	24 .1	Delivery of the Goods and performance of Services shall be made by the Supplier in accordance with the time schedule prescribed by the Purchaser in the Schedule of Requirements.
		24 .2	If at any time during performance of the Contract, the Supplier or its subcontractor(s) should encounter conditions impeding timely delivery of the Goods and performance of Services, the Supplier shall promptly notify the Purchaser in writing of the fact of the delay, its likely duration and its cause(s). As soon as practicable after receipt of the Supplier's notice, the Purchaser shall evaluate the situation and may at its discretion extend the Supplier's time for performance, with or without liquidated damages, in which case the extension shall be ratified by the parties by amendment of Contract.

MH

Rs

		24.3	Except as provided under GCC Clause 27, a delay by the Supplier in the performance of its delivery obligations shall render the Supplier liable to the imposition of liquidated damages pursuant to GCC Clause 25, unless an extension of time is agreed upon pursuant to GCC Clause 24.2 without the application of liquidated damages.
25	Liquidated Damages	25.1	Subject to GCC Clause 27, if the Supplier fails to deliver any or all of the Goods or to perform the Services within the period(s) specified in the Contract, the Purchaser shall, without prejudice to its other remedies under the Contract, deduct from the Contract Price, as liquidated damages, a sum equivalent to the percentage specified in SCC of the delivered price of the delayed Goods or unperformed Services for each week or part thereof of delay until actual delivery or performance, up to a maximum deduction of the percentage specified in SCC . Once the maximum is reached, the Purchaser may consider termination of the Contract pursuant to GCC Clause 26.
26	Termination for Default	26.1	The Purchaser or the Supplier, without prejudice to any other remedy for breach of Contract, by written notice of default sent to the concerned party may terminate the Contract if the other party causes a fundamental breach of the Contract.
		26.2	Fundamental breaches of Contract shall include, but shall not be limited to the following:
		a)	the Supplier fails to deliver any or all of the Goods within the period(s) specified

MH

RS

			in the Contract, or within any extension thereof granted by the Purchaser pursuant to GCC Clause 24; or
		b)	the Supplier fails to perform any other obligation(s) under the Contract;
		c)	The supplier has abandoned or repudiated the contract.
		d)	The Purchaser or the Supplier is made bankrupt or goes into liquidation other than for a reconstruction or amalgamation;
		e)	a payment is not paid by the Purchaser to the Supplier within 84 days of the due date for payment;
		f)	the Purchaser gives Notice that goods delivered with a defect is a fundamental breach of Contract and the Supplier fails to correct it within a reasonable period of time determined by the Purchaser; and
		g)	The supplier, in the judgment of the Purchaser, has engaged in corrupt or fraudulent practices in competing for or in exacting the Contract.
			For the purpose of this clause:
			“Corrupt practice” means the offering, giving, receiving, or soliciting of anything of value to influence the action of a public official in the procurement process or in contract execution and includes, inter alia, bribery and extortion or coercion which involves threats of injury to person, property or reputation, and

MH

Rs

			“fraudulent practice” means a misrepresentation of facts in order to influence a procurement process or the execution of a contract to the detriment of the Purchaser, and includes collusive practices among Tenderers (prior to or after Tender submission)
		26 .4	In the event the Purchaser terminates the Contract in whole or in part, pursuant to GCC Clause 26.1, the Purchaser may procure, upon such terms and in such manner, as it deems appropriate, Goods or Services similar to those undelivered, and the Supplier shall be liable to the Purchaser for any excess costs for such similar Goods or Services. However, the Supplier shall continue performance of the Contract to the extent not terminated.
27 .	Force Majeure	27 .1	Notwithstanding the provisions of GCC Clauses 24, 25, and 26, the Supplier shall not be liable for forfeiture of its performance security, liquidated damages, or termination for default if and to the extent that its delay in performance or other failure to perform its obligations under the Contract is the result of an event of Force Majeure. Such events may include, but are not restricted to, acts of the Purchaser in its sovereign capacity, wars or revolutions, fires, floods, epidemics, quarantine, restrictions, acts of terrorists and freight embargoes.

MH

Rs

		27 .2	If a Force Majeure situation arises, the Supplier shall promptly notify the Purchaser in writing of such condition and the cause thereof. Unless otherwise directed by the Purchaser in writing, the Supplier shall continue to perform its obligations under the Contract as far as is reasonably practical, and shall seek all reasonable alternative means for performance not prevented by the Force Majeure event.
28	Termination for Insolvency	28 .1	The Purchaser may at any time terminate the Contract by giving written notice to the Supplier if the Supplier becomes bankrupt or otherwise insolvent. In this event, termination will be without compensation to the Supplier, provided that such termination will not prejudice or affect any right of action or remedy that has accrued or will accrue thereafter to the Purchaser
29	Termination for Convenience	29 .1	The Purchaser, by written notice sent to the Supplier, may terminate the contract, in whole or in part, at any time for its convenience. The notice of termination shall specify that termination is for the Purchaser's convenience, the Contract is terminated, and the date upon which such termination becomes effective.
		29 .2	The Purchaser shall accept the Goods that are complete and ready for shipment within thirty (30) days after the Supplier's receipt of notice of termination at the Contract terms and price. For the remaining Goods, the Purchaser may elect:
		a)	To have any portion completed and delivered at the Contract terms and prices; and / or

MH

RS

			b)	To cancel the remainder and pay to the Supplier an agreed amount for partially completed Goods and Services and for materials and parts previously procured by the Supplier.
30	Disputes	30	.1	If any dispute or difference of any kind whatsoever shall arise between the Purchaser and the Supplier in connection with or arising out of the Contract, the parties shall make every effort to resolve amicably such dispute or difference by mutual consultation.
		30	.2	If after thirty days, the parties have failed to resolve their dispute or difference by such mutual consultation, and then either the Purchaser or the Supplier may give notice for arbitration
		30	.3	If the either party believes that a decision taken by the other was wrongly taken, the decision shall be referred to the Arbitration within 14 days of the notification of the decision.
31	Procedure for Disputes	31	.1	The Arbitration shall stated in the SCC give a decision in writing within 28 days of receipt of a notification of a dispute.

MH

Rs

		31 .2	The Arbitrator shall be paid by the hour at the rate specified in the SCC , together with reimbursable expenses of the types specified in the SCC , and the cost shall be divided equally between the Purchaser and the Supplier, whatever decision is reached by the Arbitrator. Either party may refer a decision to an Arbitrator within 28 days of the written decision. If neither party refers the dispute to arbitration within the above 28 days, the Arbitrator's decision will be final and binding.
		31 .3	The arbitration shall be conducted in accordance with the arbitration procedure published by the institution named and in the place shown in the SCC .
32	Replacement of Arbitrator	32 .1	Should the Arbitrator resign or die, or should the Purchaser and the Supplier agree that the Arbitrator is not functioning in accordance with the provisions of the Contract a new Arbitrator will be jointly appointed by the Purchaser and the Supplier. In case of disagreement between the Purchaser and the Supplier, within 30 days, the Arbitrator shall be designated by the Appointing Authority designated in the SCC at the request of either party, within 14 days of receipt of such request.
33	Limitation of Liability	33 .1	Except in cases of criminal negligence or willful conduct, and in the case of infringement pursuant to GCC Clause 8,
		a)	The supplier shall not be liable to the Purchaser, whether in contract, tort, or otherwise, for any indirect or consequential loss or damage, loss of use, loss of production, or loss of profits

MH

Rs

			or interest costs, provided that this exclusion shall not apply to any obligation of the Supplier to pay liquidated damages to the Purchaser; and
		b)	The aggregate liability of the Supplier to the Purchaser, whether under the Contract, in tort or otherwise, shall not exceed the total Contract Price, provided that this limitation shall not apply to the cost of repairing or replacing defective equipment or to any obligation of the Supplier to indemnify the Purchaser with respect to patent infringement..
34	Notices	34 .1	Any notice given by one party to the other pursuant to this Contract shall be sent to the other party in writing or by cable, telex, or facsimile and confirmed in writing to the other party's address specified in SCC . The term "in writing" means communicated in written form with proof of receipt.
		34 .2	A notice shall be effective when delivered or on the notice's effective date, whichever is later.
35	Taxes and Duties	35 .1	A foreign Supplier shall be entirely responsible for all taxes, stamp duties, license fees, and other such levies imposed outside the Zanzibar.
		35 .2	If any tax exemptions, reductions, allowances or privileges may be available to the Supplier in Zanzibar, the Purchaser shall use its best efforts to enable the Supplier to benefit from any such tax savings to the maximum allowable extent.

MH

Rs

		35 .3	A local Supplier shall be entirely responsible for all taxes, duties, license fees, etc., incurred until delivery of the contracted Goods to the Purchaser.
--	--	----------	---

MH

Rs

Special Conditions of Contract

The following Special Conditions of Contract shall supplement the General Conditions of Contract. Whenever there is a conflict, the provisions herein shall prevail over those in the General Conditions of Contract. The corresponding clause number of the GCC is indicated in parentheses.

SCC Clause Number	GCC Clause Number	Amendments of, and Supplements to, Clauses in the General Conditions of Contract
Definitions (GCC Clause 1)		
1.	1.1(i)	The Purchaser is: Zanzibar Electricity Corporation P. O Box 235 Gulioni, Zanzibar.
2.	1.1(j)	The Supplier is: Tanzania Clou Electronics Co Ltd of P. O BOX 22786, Temeke Dar es Salaam, Tanzania.
3.	1.1(k)	The Project site is: CIF Zanzibar Port,
	2	Contract effectiveness: The contract become effective from the day of being signed.
		Contract Price: TZS 1,514,366,784.00, (VAT EXCLUSIVE) ,CIF Zanzibar Port
4	2	Quantity: as per the respective order (the goods details in the Price Schedule being the first order
Governing Language (GCC Clause 3)		
5.	3.1	The Governing Language shall be: English.
Applicable Law (GCC Clause 4)		
6.	4.1	The Applicable Law shall be: Laws of Zanzibar.

MH

RS

	Country of Origin (GCC Clause 5)	
7.	5.1	Country of Origin is required: China
	Performance Security (GCC Clause 9)	
8.	9.1	The amount of performance security, as a percentage of the Contract Price, shall be 10% of contract price. The performance security shall be in the form of Unconditional Bank Guarantee or Certified Check.
	9.2	The performance security will be discharged by the Purchaser and returned to the Supplier in not later than (30) days following the date of completion of the Supplier's obligations performance under the contract including any warranty obligations.
	Inspections and Tests (GCC Clause 10)	
9.	10.1	<p>Inspection and tests prior to shipment of Goods and at final acceptance are as follows:</p> <p>Quality and quantity inspection shall be carried out prior to shipment of Goods by the manufacturer(s) at the supplier's own expense and responsibility in terms of the items specified in the specifications. The supplier shall submit the inspection certificate issued by him that should be attached with the certificate(s) of the manufacturer(s) to the Procuring Entity in order to ensure that the goods are manufactured in compliance with the contract. Factory Acceptance Test (FAT) will also be witnessed by at least two representatives from ZECO whereby all costs of the representatives from ZECO shall be borne by Supplier. In order to facilitate this, the Supplier shall give ZECO a</p>

MH

Rs

		minimum of four weeks' notice that the materials are ready for testing. NOT APPLICABLE
	Packing (GCC Clause 11)	
10.	11.2	<p>The following SCC shall supplement GCC Clause 11.2</p> <p>The Goods shall be packed properly in accordance with standard export packing specified by the Procuring Entity in the Technical Specification.</p>
	Delivery and Documents (GCC Clause 12)	
11.	12.1	<p>For Goods supplied from abroad:</p> <p>Upon shipment, the Supplier shall notify the Procuring Entity and the Insurance Company by cable the full details of the shipment, including Contract number, description of Goods, quantity, the vessel, the bill of lading number and date, port of loading, date of shipment, port of discharge, etc. The Supplier shall mail the following documents to the Procuring Entity, with a copy to the Insurance Company:</p> <p>(i.) One original plus four copies of the Supplier's invoice showing Goods' description, quantity, unit price, and total amount;</p> <p>(ii.) original and four copies of the negotiable, clean, on-board bill of lading marked "freight prepaid" and four copies of nonnegotiable bill of lading;</p>

MH

Rs

		<p>(iii.) One original plus four copies of the packing list identifying contents of each package;</p> <p>(iv.) Insurance certificates ;</p> <p>(v.) Manufacturer's or Supplier's warranty certificate;</p> <p>(vi.) inspection certificate, issued by the nominated inspection agency, and the Supplier's factory inspection report; and</p> <p>(vii.) Certificate of country of origin issued by the chamber of commerce and industry or equivalent authority in the country of origin in duplicate.</p> <p>The above documents shall be received by the Procuring and Disposing Entity at least one week before arrival of the Goods at the port or place of arrival and, if not received, the Supplier will be responsible for any consequent expenses.</p>
12.	12.3	<p>For Goods from/ within Zanzibar or Tanzania mainland.</p> <p>Upon delivery of the Goods to the transporter, the Supplier shall notify the Procuring and Disposing Entity and mail the following documents to the Procuring and Disposing Entity:</p> <p>(i.) one original plus four copies of the Supplier's invoice showing Goods'</p>

MH

RS

		<p>description, quantity, unit price, and total amount;</p> <p>(ii.) delivery note, ship receipt, or truck receipt;</p> <p>(iii.) Manufacturer's or Supplier's warranty certificate;</p> <p>(iv.) inspection certificate issued by the nominated inspection agency, and the Supplier's factory inspection report; and</p> <p>(v.) Certificate of country of origin issued by the Zanzibar Chamber of Commerce, Industry and Agriculture or equivalent authority in the country of origin in duplicate.</p> <p>The Procuring and Disposing Entity shall receive the above documents before arrival of the Goods and, if not received, the Supplier will be responsible for any consequent expenses. NOT APPLICABLE</p>
	Insurance (GCC Clause 13)	
13.	13.1	The Insurance shall be in an amount equal to 110 percent of the CIF value of the Goods from "warehouse" to "Point of destination (CIF Zanzibar Sea Port" on "All Risks" basis, including War Risks and Strikes.
	Incidental Services (GCC Clause 15)	
14.	15.1	Incidental services to be provided are: Not Applicable
	Spare Parts (GCC Clause 16)	

MF

RS

15.	16.1	Additional spare parts requirements are: NOT APPLICABLE.
Warranty (GCC Clause 17)		
16.	17.2	<p>GCC 17.2—In partial modification of the provisions, the warranty period shall be 12 months from date of acceptance of the Goods. The Supplier shall, in addition, comply with the performance and/or consumption guarantees specified under the Contract. If, for reasons attributable to the Supplier, these guarantees are not attained in whole or in part, the Purchaser shall, at its discretion, either:</p> <p>(a) Order Supplier to make such changes, modifications, and/or additions to the Goods or any part thereof as may be necessary in order to attain the contractual guarantees specified in the Contract at Supplier own cost and expense and to carry out further performance tests in accordance with SCC 14,</p> <p>or</p> <p>(b) Order Supplier to pay liquidated damages to the Procuring and Disposing Entity with respect to the failure to meet the contractual guarantees. The rate of these liquidated damages shall be 0.20 per cent per day of undelivered materials/goods value up to the sum equivalent to the amount of ten percent of the contract value.</p>
17.	17.4 & 17.5	The period for correction of defects in the warranty period is: One month.
Payment (GCC Clause 18)		

MH

Rs

18.	18.1	<p>The method and conditions of payment to be made to the Supplier under this Contract shall be as follows:</p> <p>i) After fulfilment of all required obligations 100% of the contract price shall be paid upon submission of claim supported by Bill of Lading, Commercial Invoice and other relevant documents.</p>
	18.2	<p>ii) After fulfilment of delivered of goods at Zanzibar Sea Port, and to be accepted by the Client.</p> <p>The payment shall be paid to Supplier through Supplier's Bank stated below:</p> <p>Clou Global Technology Company Limited who is the RD Material Supplier and Shipper on Behalf of Tanzania Clou Electronics Company Limited RD Material Supplier i.e.</p> <p>Name of Bank: KCB BANK TANZANIA LTD</p> <p>Address of Bank: SAMORA BRANCH</p> <p>Account Name: TANZANIA CLOU ELECTRONICS CO, LTD,</p> <p>Account Number: 3390559221</p> <p>Swift Code: KCBLTZZ</p> <p>Currency: TZS</p> <p>Payment for Goods supplied from abroad:</p> <p>Payment of foreign currency shall be made in the following manner:</p>

MH

RS

	<p>(i) Advance Payment: NOT APPLICABLE. Percent of the Contract Price shall be paid within thirty (30) days of signing of the Contract, and upon submission of claim and a bank guarantee for equivalent amount valid until the Goods are delivered and in the form provided in the Tendering documents or another form acceptable to the Procuring and Disposing Entity.</p> <p>(ii) On Shipment: NOT APPLICABLE. percent of the Contract Price of the Goods shipped shall be paid through irrevocable confirmed letter of credit opened in favor of the Supplier in a bank in its country.</p> <p>(iii) On Acceptance: 100 Percent of the Contract Price of Goods received shall be paid upon submission of claim supported by bill of lading and other documents required by purchaser through the selected reputable bank by the Procuring and Disposing Entity within thirty (30) days.</p>
	<p>Payment for Goods and Services supplied within Zanzibar or Tanzania mainland. as follows.</p> <p>(i) Advance Payment: NOT APPLICABLE. Percent of the Contract Price shall be paid within thirty (30) days of signing of the Contract against a simple receipt and a bank guarantee for the equivalent amount and in the form provided in the Tendering documents or another form acceptable to the Procuring and Disposing Entity.</p> <p>(ii) On Delivery: NOT APPLICABLE. Percent of the Contract Price shall be paid on receipt of</p>

MH

RS

		<p>the Goods and upon submission of the documents specified in GCC Clause 10.</p> <p>(iii) On Acceptance: 100 Percent of the Contract Price of Goods received shall be paid within thirty (30) days of receipt of the Goods upon submission of claim supported by the acceptance certificate issued by the Procuring and Disposing Entity.</p>
19.	18.3	<p>Rate to be used for paying the Supplier's interest on the late payment made by Purchaser shall be: NOT APPLICABLE.</p>
Contract Amendments (GCC Clause 21)		
20	21.1	<p>a. This agreement may not be amended, or otherwise extended, except by written agreement between the parties and no other purported amendment or extension thereof shall be effective.</p> <p>b. The Contract shall be valid until the fulfillment of all delivery of the goods and this contract shall commence from the date of signing the contract</p>
Prices (GCC Clause 19)		
21.	19.1	<p>Prices shall be adjusted in accordance with provisions in the Attachment to SCC. NOT APPLICABLE.</p>
Delays in the Supplier's Performance(GCC Clause 24)		
22	24	<p>The goods shall be delivered at CIF Zanzibar Port within the period specified in the Tender document from the effective date of signing the contract.</p>
Liquidated Damages (GCC Clause 25)		

MA

RS

23.	25.1	Applicable rate: 0.2 per cent per day of undelivered materials/good's value. Maximum deduction: is equal to the performance security.
Procedure for Disputes (GCC Clause 31)		
24.	31.1	The Dispute shall be referred to Zanzibar Commercial Court.
Notices (GCC Clause 34)		
25.	34.1	Procuring and Disposing Entity's address for notice purposes: The General Manager, Zanzibar Electricity Corporation, P.O. Box 235, Gulioni, <u>ZANZIBAR</u> Managing Director Tanzania Clou Electric Co. Limited, P. O BOX 22786, Dar es Salaam, <u>TANZANIA</u>

MH

Rs

**STANDARD POWER OF ATTORNEY
TO ALL IT MAY CONCERN**

THAT BY THIS POWER OF ATTORNEY given on the [20th December, 2021],

WE the undersigned **Tanzania Clou Electronics Company Limited** of **P.O Box 22786, Dar Es Salaam**, by virtue of authority conferred to us by the Board Resolution No. **BS.2021.015** of 20th day of **December, 2021**, do hereby ordain nominate and appoint **RASHID SALUM HUMOUD** of **P.O BOX 22786, DAR ES SALAAM** to be our true lawful Attorney and Agent, with full power and authority, for us and in our names, and for our accounts and benefits, to do any, or all of the following acts, in the execution of tender No. **SMZ/F0120/G/RNCB/2021-2022/01** that is to say;

To act for the company and do any other thing or things incidental for **SMZ/F0120/G/RNCB/2021-2022/01** of **SUPPLY OF ENERGY METER UNDER COVID PROJECT** for the **ZANZIBAR ELECTRICITY CORPORATION** of **P. O. Box 235, Zanzibar, Tanzania**;

AND provided always that this Power of Attorney shall not revoke or in any manner affect any future power of attorney given to any other person or persons for such other power or powers shall remain and be of the same force and affect as if this deed has not been executed.

AND we hereby undertake to ratify everything, which our Attorney or any substitute or substitutes or agent or agents appointed by him under this power on his behalf herein before contained shall do or purport to do in virtue of this Power of Attorney.

SEALED with the common seal of the said **TANZANIA CLOU ELECTRONICS COMPANY LTD** and delivered in the presence of us this 20th day of **December, 2021**.

IN WITNESS whereof we have signed this deed on this 20th day of **December, 2021** at Dar es Salaam, Tanzania for and on behalf of **TANZANIA CLOU ELECTRONICS COMPANY LTD**.

SEALED and DELIVERED by the
Common Seal of **Tanzania Clou Electronics Company Limited**
This 20th, **December, 2021**.

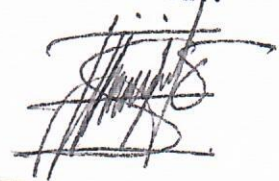

DONOR

BEFORE ME:

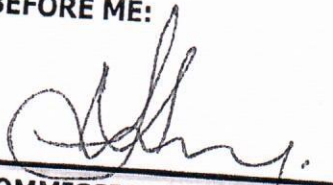
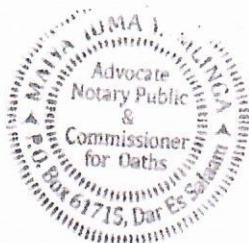
COMMISSIONER OF OATH

MH

Rs

ACKNOWLEDGEMENT

I **RASHID SALUM HUMOUD** doth hereby acknowledge and accept to be Attorney of the said **Tanzania Clou Electronics Company Limited** under the terms and conditions contained in this POWER OF ATTORNEY and I promise to perform and discharge my duties as the lawfully appointed Attorney faithfully and honestly.

SIGNED AND DELIVERED by the said
RASHID SALUM HUMOUD Identified to me
by **Tanzania Clou Electronics Company Limited**
The latter known to me personally
This 20th December, 2021.



DONEE

BEFORE ME:

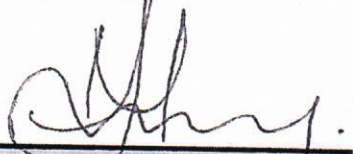

COMMISSIONER FOR OATHS

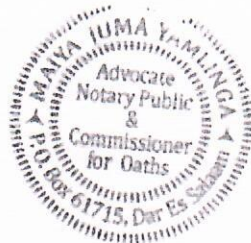

MH

Rs

PROCUREMENT OF ELECTRICITY ENERGY METERS					
s/n	Item	Quantity	Unit price	Unit	Total value
1	Single phase pre paid meters	20,302	74,592.00	PC	1,514,366,784.00
	Total cost				1,514,366,784.00

MH

Rs

Undertaking by Bidder on Anti - Bribery Policy

[The Public Procurement and Disposal of Public Assets Act No. 11 of 2016 –Section 89(2)]

MEMORANDUM

This company Tanzania Clou Electronics Company Limited places importance on competitive tendering taking place on a basis that is free, fair, competitive and not open to abuse. It is pleased to confirm that it will not offer or facilitate, directly or indirectly, any improper inducement or reward to any public officer their relations or business associates, in connection with its tender, or in the subsequent performance of the contract if it is successful.

Our company has an Anti-Bribery Policy/Code of Conduct and a Compliance Program which includes all reasonable steps necessary to assure that the No-bribery commitment given in this statement will be complied with by its managers and employees, as well as by all third parties working with this company on the public sector projects, or contract including agents, consultants, consortium partners, sub- contractors and suppliers. Copies of our Anti-Bribery Policy/Code of Conduct and Compliance Program are attached.

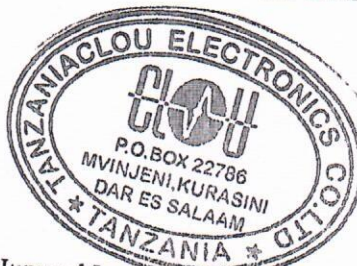

Authorized Signature:

R. Humoud

Name and Title of Signatory: Rashid Salum Humoud In the capacity of Sales Manager

Name of Tender: Tanzania Clou Electronics Company Limited

Address: Plot no 35, Block C, Kurasini industrial area, Temeke, DAR es Salaam, Tanzania

MH

RS

Manufacturer's Authorization

Date: 23rd December, 2021

Bid No: SMZ/F0120/G/RNCB/2021-2022/01

To: **Zanzibar Electricity Corporation (ZECO)**

WHEREAS **TANZANIA CLOU ELECTRONICS COMPANY LIMITED** who are established and reputable manufacturers of **Single Phase Pre-paid Meters Complete with Enclosures**, having factories at **Plot no 35, Block C, Kurasini industrial area, Temeke, Dar Es Salaam, Tanzania,**

Do hereby authorize **TANZANIA CLOU ELECTRONICS COMPANY LIMITED** to submit a Bid, and subsequently negotiate and sign the Contract with you against **IFT No. SMZ/F0120/G/RNCB/2021-2022/01** for the above goods manufactured by us.

We hereby extend our full guarantee and warranty as per Clause 17 of the General Conditions of Contract for the goods offered for supply by the above firm against this Invitation for Bids.

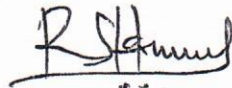

Name: **RASHID SALUM HUMOUD**

Title: **OPERATION MANAGER**



Duly authorized to sign this Authorization on behalf of: **TANZANIA CLOU ELECTRONICS COMPANY LIMITED**

Dated on: 22nd day of **DECEMBER, 2021**

MH

RS

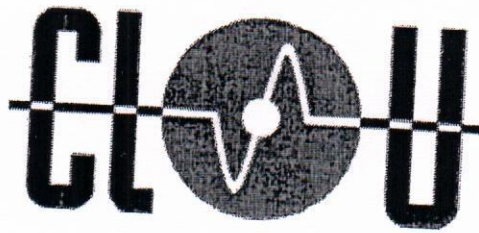

ZANZIBAR ELECTRICITY CORPORATION
P.O Box 235, Zanzibar - Tanzania.

TECHNICAL PART

TANZANIA CLOU ELECTRONICS CO., LTD
Plot no 35, Block C, Kurasini industrial area, Temeke, Dar es Salaam, Tanzania
Web: www.clouglobal.com, P.O. Box 22786

MH

RS



ZANZIBAR ELECTRICITY CORPORATION
P.O Box 235, Zanzibar - Tanzania.

Single Phase Meter Box (CL754WJ)

- ❖ Specification for Meter Box
- ❖ Brochure of Single Phase Meter Box CL754WJ
- ❖ Outline Dimension Drawing of Single Phase Meter Box CL754WJ
- ❖ Meter Box Routine Test Report for Single Phase Meter Box CL754WJ

TANZANIA CLOU ELECTRONICS CO., LTD
Plot no 35, Block C, Kurasini Industrial area, Temeke, Dar es Salaam, Tanzania
Web: www.clouglobal.com, P.O. Box 22786

MH

RS

REQUIREMENTS				
1	Housing material		Flame retardant material ABS or similar (Polycarbonate)	Polycarbonate
2	Housing wall thickness	mm	Minimum 4	4mm
3	Front window material		Flame retardant material ABS or similar (Polycarbonate)	Polycarbonate
4	Dimensions of collapsible window pane	mm	Specify	231.2*123.6 mm
5	Is keypad accessible through the collapsible window (without opening the meter box)?	Yes/No	Yes	Yes
6	Can the circuit breaker be operated without opening the meter box?	Yes/No	Yes	Yes
7	General quality of the meter box	Good/In ferior	Good	Good
8	Dimension of the meter box	mm	L = W =	L=231.2 W=231.22 D=113.0
9	Are keys supplied	Yes/No	Yes	Yes
10	Can locking bolts be sealed?	Yes/No	Yes	Yes
11	Is Sample submitted?	Yes/No	Yes	Yes

Name: Rashid Salum Humoud of Sales Manager

Signed: 



Duly authorized to sign the bid for and on behalf of Tanzania Clou Electronics Company Limited

Add: CLOU Building, Hi-tech Industry Park North, Baoshen Road South, Shenzhen, China
 Tel: 0755-33309999 Web: www.clouglobal.com Email: oversea@szclou.com P.C.: 518057

MH

RS



CL754WJ

Single Phase Meter Enclosure

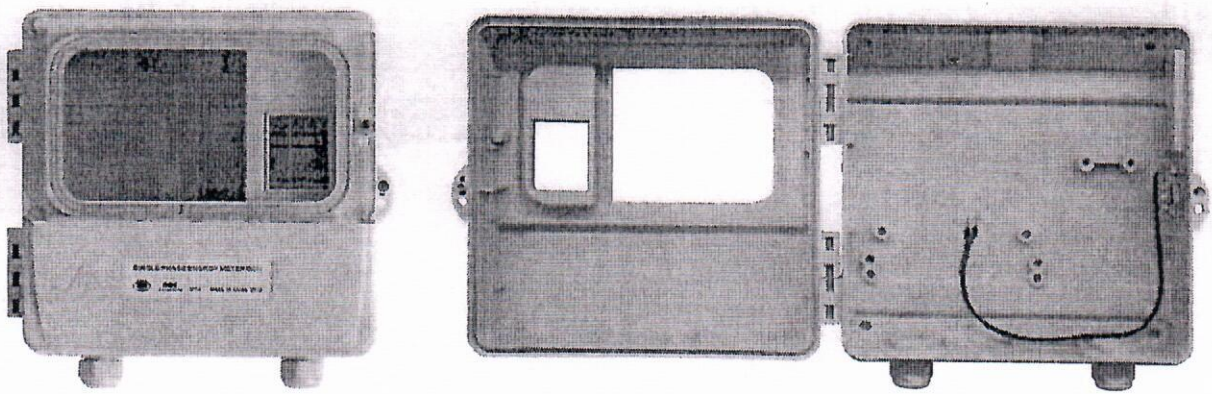

CL754WJ

The meter enclosure is exclusively designed for the purpose of anti-tamper and protection of energy meter. The material of the enclosure is polycarbonate and ABS, or polycarbonate and fiberglass. CL754WJ enclosure can accommodate: 2 pcs DIN rail mounted meters, or 1 pcs single phase meter with bottom connection.

Standard features

- Protection rating: IP54
- Water proof
- Dust proof
- UV resistant
- Small size and easy installation
- Available for prepaid and credit meters
- Sealable lock
- Detect when open meter box, tamper detect and record event

Options

- Meter Circuit Breaker (MCB)
- Lock and key protection



AGH

RS

CL754WJ

Single Phase Meter Enclosure

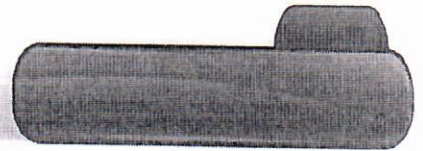

Dimension

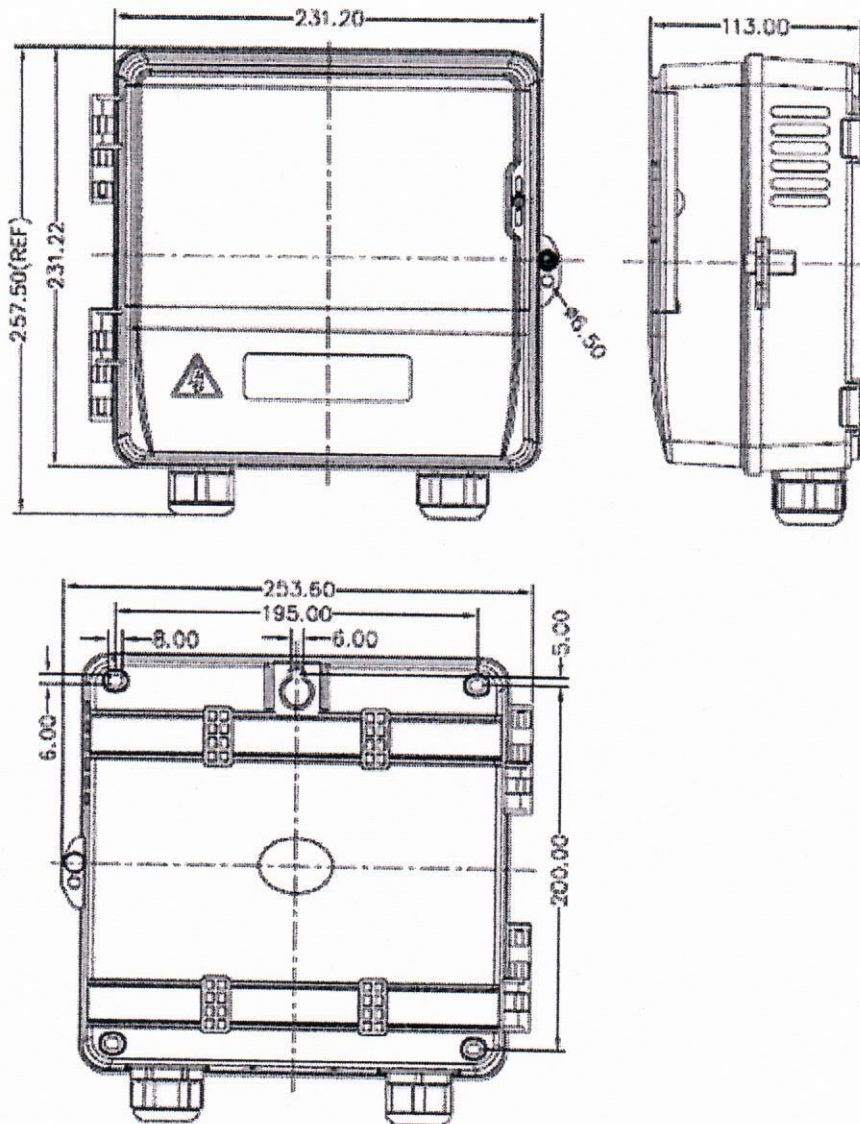

Unit: mm

Add: Plot no 35, Block C, Kurasini Industrial area, Temahe, DAR es Salaam, Tanzania
Web: www.clouglobal.com P.O.Box 22786

MH

RS

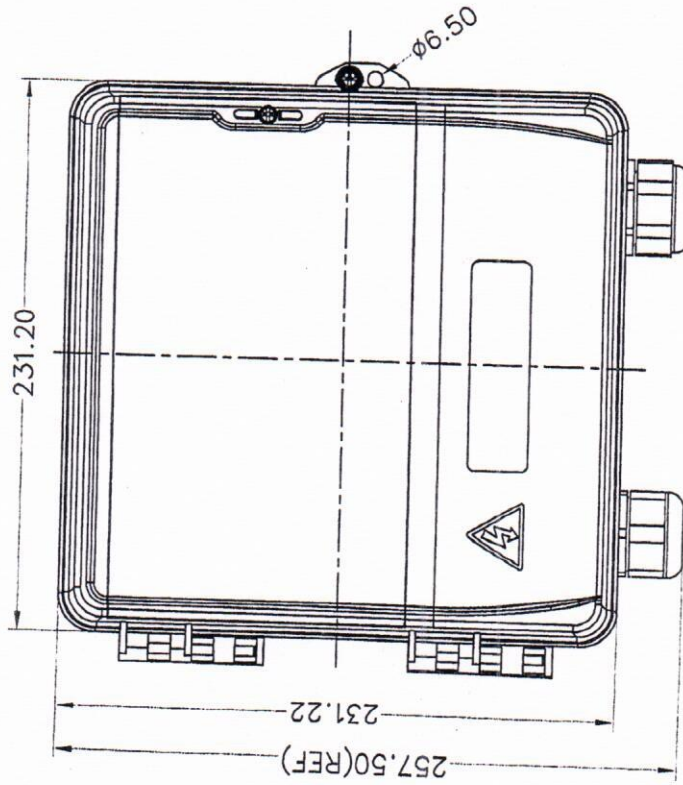
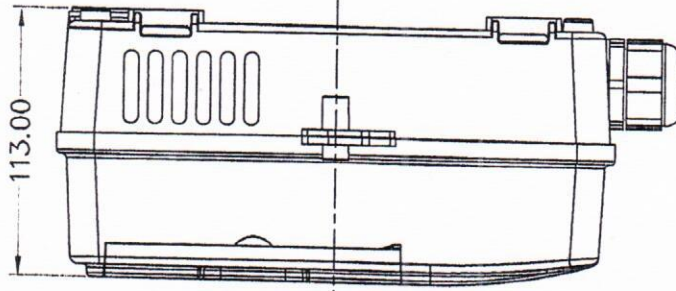
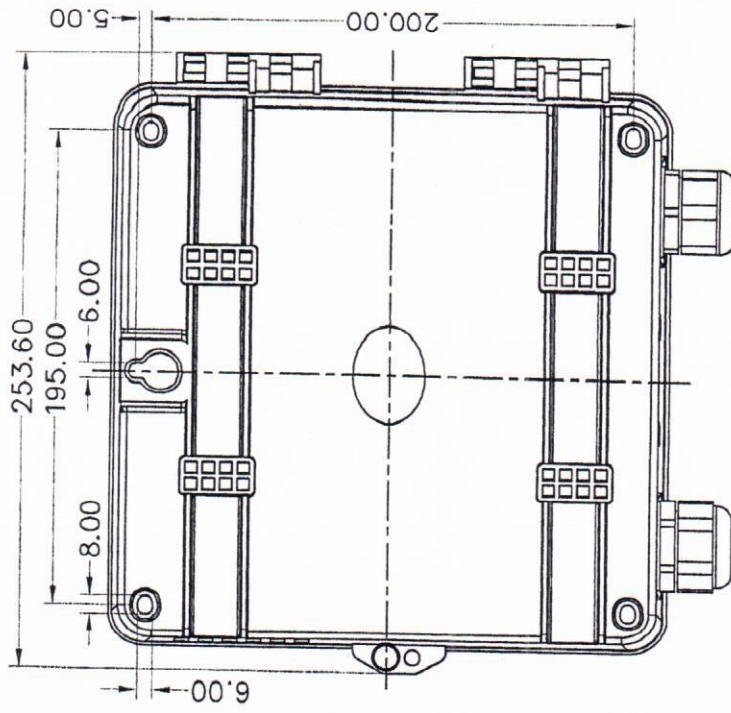

Outline Dimension Drawing of Single phase Meter Box

257.5 * 253.6 * 113 mm

MW

RS



Test Report

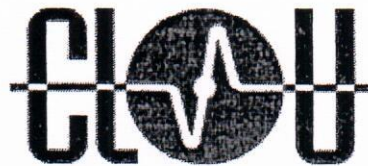

Model No:

CL754WJ

Product:

Single Phase Meter Box

Date:

21st Dec, 2021

—CLOU Testing Center—

MH

RS



Table of Content

Test Information	2
Test Item	3
1. Outlook Inspection	4
1.1 Outlook Inspection	4
2. Mechanical Test	4
2.1 Corrosion Resistance Test.....	4
2.2 External mechanical impact protection grade (IK) code validation test.....	5
2.3 IP Class Verification Test.....	5
2.4 Heat Resistance Test.....	6
2.5 Abnormal Heat and Fire Resistance Test.....	6
2.6 Resistance to Aging Test	7
2.7 Plastic Impact Test	7
2.8 Plastic Stretch Test.....	7
2.9 Plastic Bending Test.....	8
3. Physical and Chemical Test.....	8
3.1 Protective coating test.....	8
3.2 Solar Radiation Test.....	9
Annex: Meter Box Material (PC+ABS) Test Report.....	10

MH

RS

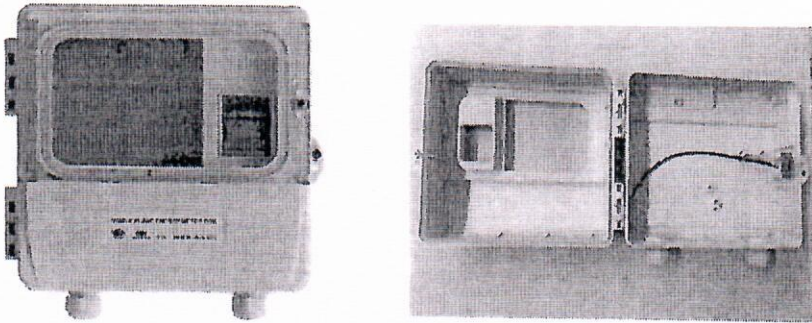
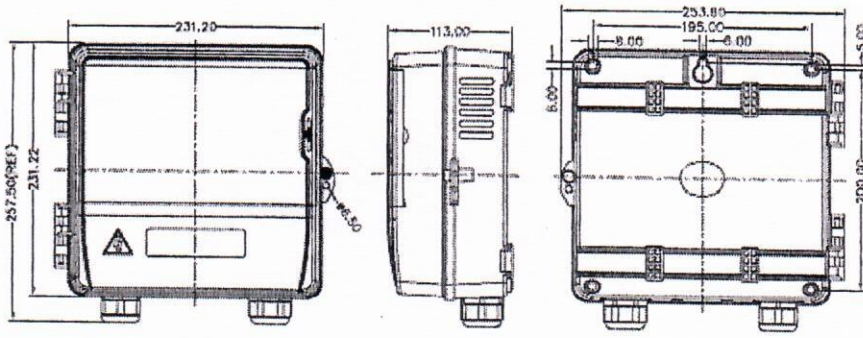

Test Information

Test Type	Routine Test		
Model No	CL754WJ	Name	Meter Box for Single Phase Meter
Test Environment	23±2 °C 45%RH~75%RH	Testing Date	2021.12.20-2021.12.21
Sample Picture			
Sample Dimension			

MH

Rs



Test Item

No.	Test Item		Result
1	Outlook Inspection	Outlook Inspection	Qualified
2	Mechanical test	Corrosion resistance test	Qualified
3		Mechanical impact test	Qualified
4		IP test	Qualified
5		Heat resistance test	Qualified
6		Abnormal heat and fire resistance test	Qualified
7		Aging resistance test	Qualified
8		Plastic impact test	Qualified
9		Plastic stretch test	Qualified
10		Plastic bending test	Qualified
11	Physical and chemical test	Protective coating test	Qualified
12		Solar radiation test	Qualified

MH

RS



Test Content

1. Outlook Inspection

1.1 Outlook Inspection

a) Test standard

Q/GDW 11008-2013 Low voltage meter box technical standard

b) Test method

Through visual inspection to verify whether the outlook can meet the standard or not.

c) Conclusion

Technical Requirement	Result	
	1#	2#
Coating should be flat, no leafing, bubble or scratch	Qualified	Qualified
Identification, warning sign, name plate, diagram should be clear and right content.	Qualified	Qualified
The moving parts, connection parts of meter box	Qualified	Qualified
Meter, sensor installation location testing	Qualified	Qualified
Full set attached document	Qualified	Qualified

Remark: Pass

2. Mechanical Test

2.1 Corrosion Resistance Test

a) Test standard

Q/GDW 11008-2013 Low voltage meter box technical standard

GB 7251.5-2008 Low-voltage switchgear and control gear assemblies - Part 5: Particular requirements for assemblies for power distribution in public networks

b) Test result

Technical requirement	Result	
	1#	2#
After test, the IP class of sample should not change and the door should operate normally.	Qualified	Qualified

Remark: Pass

MH

RS

Q/GDW 11008-2013 Low voltage meter box technical standard

GB/T 20138-2006 Degrees of protection provided by enclosures for electrical equipment against external mechanical impacts (IK code)

GB/T 20641-2006 Low voltage switchgear and control equipment normal requirement

GB/T 2423.55 Environmental testing for electric and electronic products:

b) Test method: Hammer test

c) Test result:

Technical requirement	Result	
	1#	2#
After test, the dielectric strength and outlook of meter box should not change; the installation components should not loose or fall down; door should not be broken or damaged and can open or close properly; electric clearance should not change; the short circuit continuity protection and performance index should be remained the same.	Qualified	Qualified

Remark: Pass

2.3 IP Class Verification Test

a) Test standard

Q/GDW 11008-2013 Low voltage meter box technical standard

GB 4208-2008 Meter box IP class

GB/T 20641-2006 Low voltage switchgear and control equipment normal requirement

b) Test requirement

Technical requirement	Result	
	1#	2#
Test should meet standard requirement (IP54)	Qualified	Qualified

Remark: Pass

MH

RS



2.4 Heat Resistance Test

a) Test requirement

Q/GDW 11008-2013 Low voltage meter box technical standard

GB/T 20641-2006 Low voltage switchgear and control equipment normal requirement

b) Test result

Technical requirement	Result	
	1#	2#
After test, the indentation diameter made by measuring ball should not exceed 2 mm	Qualified	Qualified

Remark: Pass

2.5 Abnormal Heat and Fire Resistance Test

a) Test standard

Q/GDW 11008-2013 Low voltage meter box technical standard

GB/T 20641-2006 low voltage switchgear and control equipment normal requirement

b) Test method

This test is for nonmetal meter box and insulation accessories inside box, testing the thinnest part of the insulating material case and other rest parts. The temperature of the top of glow wire as below

—Insulation material and the insulation accessories: $(650 \pm 15)^\circ\text{C}$.

Requirement: observe the sample and record the fire on and fire off time during the test.

c) Test result

Technical requirement	Result	
	1#	2#
Have no obvious fire or continued light	Qualified	Qualified

Remark: Pass

MH

RS



2.6 Resistance to Aging Test

a) Test standard

Q/GDW 11008-2013 Low voltage meter box technical standard

GB/T 20641-2006 low voltage switchgear and control equipment normal requirement

b) Test result

Technical requirement	Result	
	1#	2#
Nonmetallic material bending degree and pendulum impact strength reduction should be no more than 30%;Metal shell protective layer should keep at least 50%;Samples should not be broken or damaged; Film adhesion, impact resistance of metal material metering box should not change.	Qualified	Qualified

Remark: Pass

2.7 Plastic Impact Test

a) Test standard

Q/GDW 11008-2013 Low voltage meter box technical standard

GB/T 1043.1 The impact properties of simply supported beam part 1: The instrumented impact test

b) Test result

Technical requirement	Result	
	1#	2#
Plastic charpy impact strength $\geq 45\text{kJ/m}^2$	Qualified	Qualified

Remark: Pass

2.8 Plastic Stretch Test

a) Test standard

Q/GDW 11008-2013 Low voltage meter box technical standard

GB/T 1040.2 -2006 Plastic tensile property testing part 2: Molding and extrusion plastic

MH

RS



test conditions

GB/T 1447-2005 Fiber reinforced plastic tensile performance test methods

b) Test method

Used to test meter box material tensile property for nonmetal (plastic) meter box. Testing method according to GB/T 1040.2, GB/T 144.

c) Test result

Technical requirement	Result	
	1#	2#
Tensile property $\geq 40\text{MPa}$	Qualified	Qualified

Remark: Pass

2.9 Plastic Bending Test

a) Test standard

Q/GDW 11008-2013 Low voltage meter box technical standard

GB/T 9341 Plastic bending property testing method

b) Test result

Technical requirement	Result	
	1#	2#
Bending property $\geq 56\text{MPa}$	Qualified	Qualified

Remark: Pass

3. Physical and Chemical Test

3.1 Protective coating test

3.1.1 Adhesion test

a) Adhesion test

Q/GDW 11008-2013 Low voltage meter box technical standard

GB/T 9286-1998 Paint and varnish paint film drawing test

b) Test result

Technical requirement	Result

MH

Rs



	1#	2#
Test results should meet the requirements of the standard test results classification level I	Qualified	Qualified

Remark: Pass

3.2 Solar Radiation Test

a) Test basis

GB/T 2423.24-2013 Environmental testing. Part 2: Test methods. Test Sa: Simulated solar radiation at ground level and guidance for solar radiation testing

b) Test result

Test environment	Test requirement	Result
Temperature: 40°C Irradiation time: 8hrs Obmub: 16hrs Test period: 3days	The outlook, especially the sign and picture on the box should not be changed	Qualified

MH

RS



Annex: Meter Box Material (PC+ABS) Test Report



深圳市盈实科技有限公司

SHENZHEN YINGSHI TECH CO.,LTD

物性检测报告

料号(Material Name)	20490000000060	批号(LOT No.)	YS201-1001059
规格(Grade)	PC+ABS 03U	出货日期(Date)	2016-01-25

物性性能				
	项目(Item)	方法(Method)	单位(Unit)	数值(Data)
物理性质测试 Physical Property	熔融指数 Melt Index	D-1238 260°C/2.10KG	g/10min	17.6
	比重 Specific Gravity	D-792		1.19
	热变形 H.D.T 1.8Mpa	D-648	°C	91.6
机械性质测试 Mechanical Property	拉伸强度 Tensile Strength	D-638	Kg/cm ²	611
	延伸率 Elongation	D-638	%	81
	冲击强度 Flexural Strength	D-790	Kg/cm ²	892
	弯曲模数 Flexural Modulus	D-790	Kg/cm ²	23247
	冲击强度 (Izod Impact Notched 10°C)	D-256	Kg-cm/cm	74
耐燃性测试 Flame Characteristics property	冲击强度 (Izod Impact Notched 0°C)	D-256	J/M	723.2
	垂直燃烧 Vertical Burning	UL94	1/8英寸	VO
外观检测 Optical Property	色差报告 Color Difference Report	CIE Lab		OK
	异色点			OK
	薄片			OK

加工性能			
加工性能 PROCESSING PROPERTY	典型数值 VALUE	单位 UNIT	备注 REMARK
加工温度范围 MELT TEMPRANGE	210-250	°C	
最佳加工温度 MELT TEMPOPTIMUM	230	°C	
模具温度 MOLD TEMPRANGE	80-90	°C	
干燥温度 DRYING TEMPERTURE	90-100	°C	
干燥时间 DRYING TIME	≥4	H	
含水率 MOISTURE CONTENT	0.02	%	

环保:

Cd	Pb	Hg	Cr	B+
0	0	0	0	543

这些典型性能数据数据均是相似值,只是产品规格的一部分,其中数据只作为参考用

审核(Approve by):

检测(responsible):

MH

RS

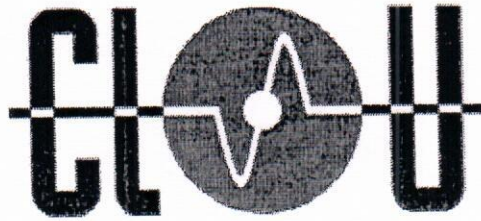

ZANZIBAR ELECTRICITY CORPORATION
P.O Box 235, Zanzibar - Tanzania.

Single Phase Prepaid Meter (CL710K16)

TANZANIA CLOU ELECTRONICS CO., LTD
Plot no 35, Block C, Kurasini industrial area, Temeke, Dar es Salaam, Tanzania
Web: www.clouglobal.com, P.O.Box 22786

MH

RS



ZANZIBAR ELECTRICITY CORPORATION
P.O Box 235, Zanzibar - Tanzania.

Technical Data Schedule, Non Compliance Schedule & Meter Brochure

TANZANIA CLOU ELECTRONICS CO., LTD
Plot no 35, Block C, Kurasini industrial area, Temeke, Dar es Salaam, Tanzania
Web: www.clouglobal.com, P.O. Box 22786

MH

RS

Manufacturer		Tanzania CLOU Electronics Co., Ltd.
Manufacture's Type Designation		Single Phase Prepayment Energy Meter
Catalogue Number		CL710K16
International standard it complies with		IEC521, IEC1036, IEC62052-11, IEC62053-21, IEC62055-31
Reference Frequency	Hz	50Hz
Reference Voltage	V	230V
Basic Current (I _b)	A	10A
Maximum Current (I _{max})	A	60A
Minimum Measuring Current	A	0.04A (0.4%I _b)
Basic Impulse Level	kV	12KV
50Hz 1 min. withstand voltage at 40 °C and 100% humidity	kV	4.1KV
Short Circuit Current for 0.5s	kA	1.8KA
Reference temperature	°C	23.5 °C
Temperature coefficient	%/ °C	0.1
Overload capacity: from an accuracy point from a temperature rise point of view	% %	20% 20%
Continuous over voltage capacity	V	440V
Burden of voltage coil	VA/W	10VA/2W
Burden of current coil	VA/W	4VA/2.5W
Breaking capacity of a current operated circuit breaker	kA	2.5kA
Meter constant	Pulse/kWh	1000 imp/kWh 1000 imp/kvarh
Limits of reference voltage for "no creep", current circuit disconnected	V	Limits of reference voltage for "no creep": 115V-253V; Current circuit disconnected: when voltage higher than 253V or lower than 115V (these value can be set by PC Software), the relay will open and circuit disconnected.
Limit of error:		
0.1 to 0.5 basic current, PF=1	%	±1.0
basic to maximum current, PF=1	%	±1.0
basic current with PF=0.5, lagging	%	±1.0
Class Index:		Active 1.0 Reactive 2.0

Add: Plot no 35, Block C, Kurasini industrial area, Temeke, DAR es Salaam, Tanzania
Web: www.clouglobal.com P.O.Box 22786

MH

RS

CLOU TANZANIA CLOU ELECTRONICS COMPANY LIMITED

Standard meters have been tested to		China Quality Supervision and Inspection Center for Electrical Measuring Instruments
Can meter be adjusted for: full load? (y/n)		Y
Low load? (y/n)		Y
Material of meter case		Polycarbonate+10% Glassfiber
Expected service life (approved by an independent laboratory)	years	≥ 12 years
Expected period free from service or maintenance		12 year
Dimensions: Width	mm	112.0 mm
Depth	mm	56.0 mm
Height	mm	174.6 mm
Net weight	kg	0.6 kg
Sample submitted		Yes

Name Rashid Salum Humoud of Sales Manager

Signed

Rashid Salum Humoud

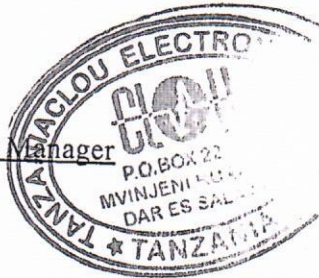

Duly authorized to sign the bid for and on behalf of Tanzania Clou Electronics Company Limited

MH

RS



Non-Compliance Schedule

Date: 23rd December, 2021

Bid No: SMZ/F0120/G/RNCB/2021-2022/01

To: Zanzibar Electricity Corporation (ZECO)

Regarding the Bid No. SMZ/F0120/G/RNCB/2021-2022/01 for Supply of Energy Meters under Project of Supply of assorted electrical materials

Clause No.	Non Compliance
N/A	N/A

Signed: 

Name: Rashid Salum Humoud

In the capacity of Sales Manager

Duly authorised to sign the tender for and on behalf of TANZANIA CLOU ELECTRONICS COMPANY LIMITED

Dated on 22nd day of December, 2021

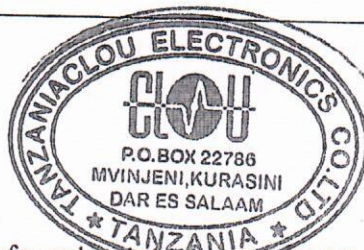

MH

RS



CL710K16

Single Phase Prepayment Energy Meter

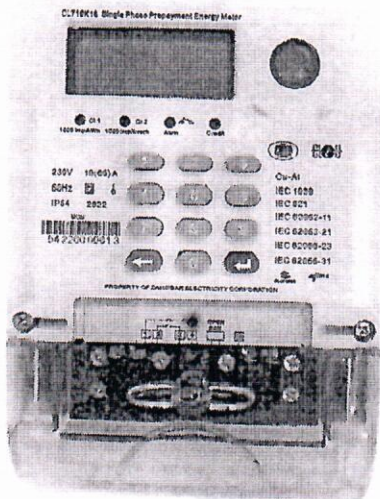

CL710K16

The CL710K16 Single Phase Prepayment Energy Meter is STS certificated meter, compliant with IEC62053, IEC62052 standards. The main measurement and control unit (MCU) is in British mounting structure. It is mounted in meter box inaccessible for the user.



Basic Functions

- STS compliant
- Reverse energy (A-) can be measured in forward way (A+)
- Tamper function for
 - Meter Cover open detection
 - Current unbalance
- Event log
- Load control
- Pre-alarm function
- LCD display items configurable
- Recent 10 times charging token and charging amount query
- 12 months energy consumption record
- Infrared and SCSSCAA9 communication
- Detection of meter box open
- Real time clock
- Multi tariff
- By-pass
- Measurement in phase and neutral

MH

RS

CL710K16

Single Phase Prepayment Energy Meter

Dimension Figure

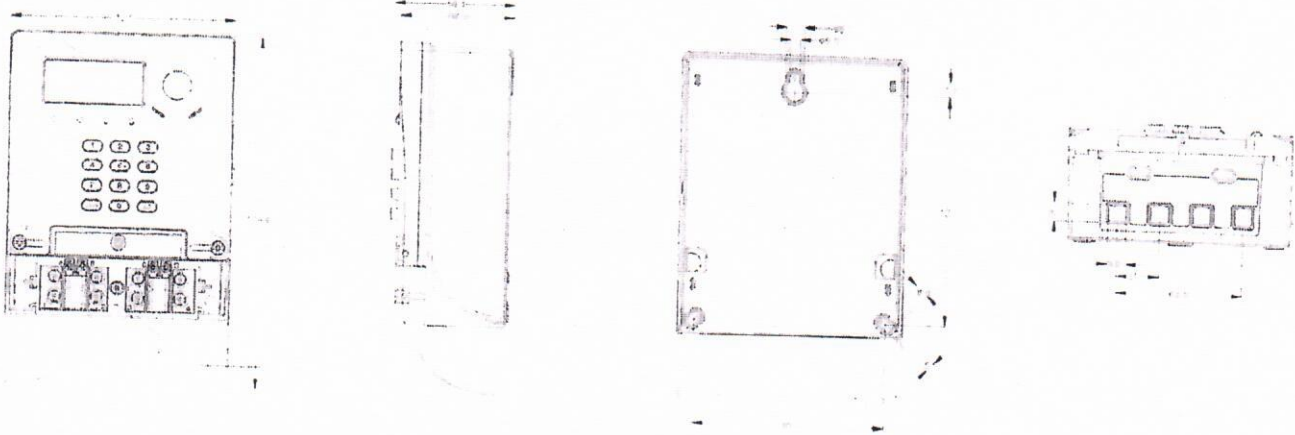

Technical Parameters

Item	Parameter
Rated Voltage (UN)	230 V
Working Voltage Range	115 V ... 253 V
Rated Frequency	50 Hz
Base Current (Ib)	10 A
Maximum Current (Imax)	60 A
Starting Current	0.4 % Ib
Voltage Circuit Power Consumption	≤ 2 W 10 VA
Current Circuit Power Consumption	≤ 4 VA
Display	LCD
Meter Constant	1000 imp / kWh, 1000 imp / kvarh
Working Temperature Range	-25 °C ... 55 °C
Storage Temperature Range	-40 °C ... 70 °C
Humidity	≤ 95 %
Accuracy Class	Class 1.0 active, Class 2.0 reactive
Communication Interfaces	Infrared and SCSSCAA9 communication
Weight (MCU)	0.6 Kg
Service Life Span	≥ 12 years

MH

RS